

## Procedures to file a request to the SPTO for Patent Prosecution Highway Pilot Program between the Spanish Patent and Trademark Office (SPTO) and the Turkish Patent Institute (TPI)

### PPH using national work products from the TPI

#### Request to the SPTO

**[0001]** An applicant should file a request for accelerated examination under the Patent Prosecution Highway (PPH) to the SPTO by submitting an application requesting accelerated examination under the PPH accompanied by the relevant supporting documents. The requirements for an application to the SPTO for accelerated examination under the PPH are given in the following section. Relevant supporting documentation is discussed in a latter section (paragraphs [0003] to [0005]) as is the general SPTO application procedure envisaged at this time (paragraph [0006]).

#### Requirements for requesting an accelerated examination under the PPH Pilot Program at the SPTO

**[0002]** The requirements for requesting accelerated examination under the PPH pilot program at the SPTO are:

***(a) Both the SPTO application on which PPH is requested and the TPI application(s) forming the basis of the PPH request shall have the same earliest date (whether this be a priority date or a filing date).***

*For example, the SPTO application (including PCT national phase application) may be either:*

- i) an application which validly claims priority under the Paris Convention to the OEE application(s) (examples are provided in ANNEX 1), or
- ii) a PCT national/regional phase application where both the OLE application and the OEE application(s) are derived from a common PCT international application having no priority claim (examples are provided in ANNEX 1).
- iii) an application which validly claims priority under the Paris Convention to the PCT application(s) without priority claim (examples are provided in ANNEX 1).
- iv) an application which is the basis of a valid priority claim under the Paris Convention for the OEE application(s) (including PCT national/regional phase application(s)) (examples are provided in ANNEX 1),
- v) an application which shares a common priority document with the OEE application(s) (including PCT national/regional phase application(s)) (examples are provided in ANNEX 1).

***(b) At least one corresponding TPI application has one or more claims that are determined to be patentable/allowable by the TPI.***

***(c) All the claims on file, as originally filed or amended, for examination in the SPTO under the PPH must sufficiently correspond to one or more of those claims indicated as patentable/allowable by the TPI.***

Claims are considered to 'sufficiently correspond' where, accounting for differences due to translations and claim format, the claims in the SPTO application are of the same or similar scope as in the TPI application, or the claims of the TPI application are narrower in scope than the claims in the TPI application.

In this regard, a claim that is narrower in scope occurs when a TPI claim is amended to be further limited by an additional feature that is supported in the specification (description and/or claims). Narrower claims can be written as dependent claims.

A claim in the SPTO application which introduces a new/different category of claims to those claims indicated to be patentable/allowable in the TPI application is not considered to sufficiently correspond. If, for example, the TPI claims only contain claims to a process of manufacturing a product, then the claims in the SPTO application are not considered to sufficiently correspond if the claims of the SPTO application introduce product claims that are dependent on the corresponding process claims.

Any claims amended or added after the grant of the request for participation in the PPH Pilot Program need to sufficiently correspond to the claims indicated as patentable/allowable in the TPI application.

***(d) SPTO has not begun examination of the application.***

**Required documents for accelerated examination under the PPH Pilot Program at the SPTO**

**[0003]** The following documentation will be needed to support a request for accelerated examination under the PPH pilot program at the SPTO:

a) a copy of all the office actions (which are relevant to the patentability) in the corresponding TPI application(s), and translations of them. Office actions are documents which relate to substantive examination and which were sent to the applicant by the TPI examiner. The applicant can either provide these with the request for acceleration under the PPH or request that the SPTO obtain the documents required through the TPI document database.

Both Spanish and English are acceptable as translation language. Machine translations are admissible, but if it is impossible for the examiner to understand the outline of the translated office action or claims due to insufficient translation, the examiner can request the applicant to resubmit translations.

b) a copy of the claims found to be patentable/allowable by the TPI and translations of them. The applicant can either provide these with the request for acceleration under the PPH or request that the SPTO obtain the documents required through the TPI document database. Both Spanish and English are acceptable as translation language. The indications provided in the requirement [0003](a) above regarding machine translations also apply to this requirement [0003](b).

c) a complete claim correspondence table showing the relationship between the claims of the SPTO application for accelerated examination under the PPH and the claims of the corresponding TPI application considered patentable/allowable by the TPI. Sufficient correspondence of claims occurs where claims are of the same or similar scope.

The claims correspondence table must indicate how the claims in the SPTO application correspond to the patentable/allowable claims in the TPI application. The claim correspondence table must be written in Spanish or English.

d) copies of the references cited by the TPI examiner. If the references are patent documents, it will not be necessary to submit these documents, as they will usually be available to the SPTO. If the SPTO does not have access to relevant patent documents, the applicant must submit these documents at the request of the SPTO. Non-patent literature must always be submitted. Translations of cited references are unnecessary.

**[0004]** The relevant information is obtained from the applicant by filling out a form for requesting accelerated examination under the PPH Pilot Program (see Annex 2) which is available on the SPTO web site. The relevant supporting documentation should be attached.

**[0005]** The applicant need not provide further copies of documentation if they have already been submitted to the SPTO through simultaneous or past procedures.

### **Procedure for accelerated examination under the PPH Pilot Program at the SPTO**

**[0006]** The applicant fills out the form requesting accelerated examination under the PPH Pilot Program (see Annex 2) available on the SPTO website and includes all the relevant supporting documents. The PPH Administrator, who will be an SPTO patent examiner, will consider the request. Where all the requirements for accelerated examination under the PPH have not been met, the PPH Administrator will notify the applicant that the application has not been allowed entry on to the PPH and will provide an explanation as to why entry on to the PPH was denied. The applicant is free to take any possible correcting action necessary and again requesting acceleration under the PPH.

If all requirements for accelerated examination under the PPH are met, the PPH Administrator will notify the applicant that the application has been allowed entry on to the PPH. The PPH Administrator will notify the relevant examining group that the application has qualified for entry to the PPH and the relevant examiner will then conduct an accelerated examination of the application.

If the request for accelerated examination is not granted, the applicant will be notified that the application will await action in its regular turn.

# Annex 1

## CASE I

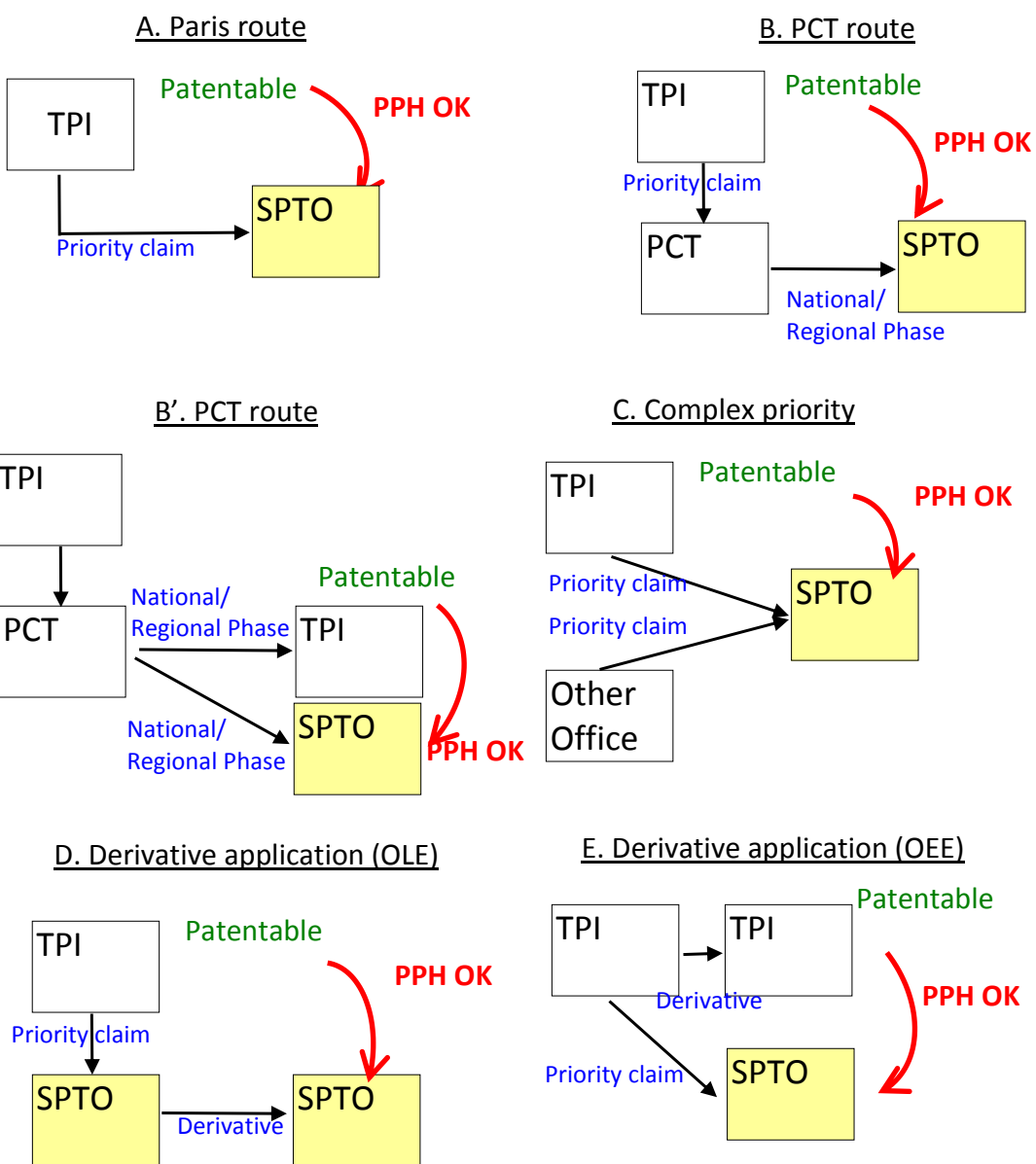

**CASE II**

F. Direct PCT route

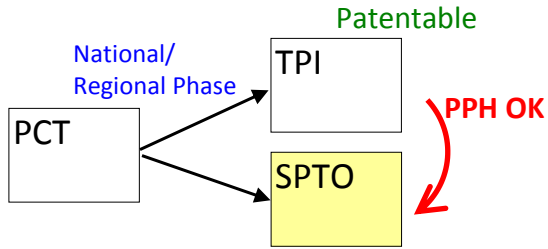

**CASE III**

G. Direct PCT & Paris route  
Without priority claim

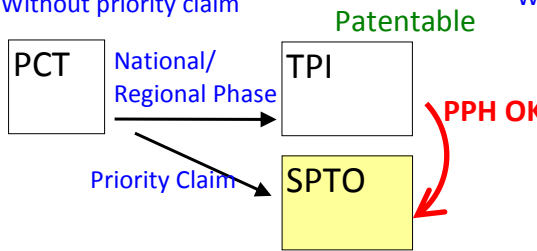

H. Direct PCT & PCT route  
Without priority claim

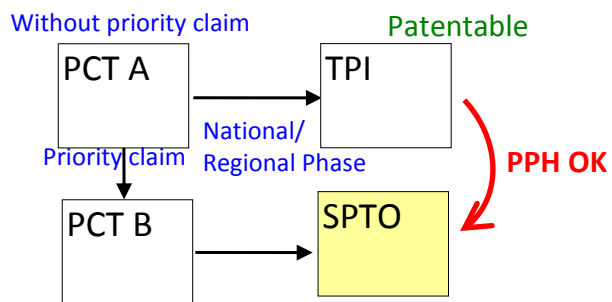
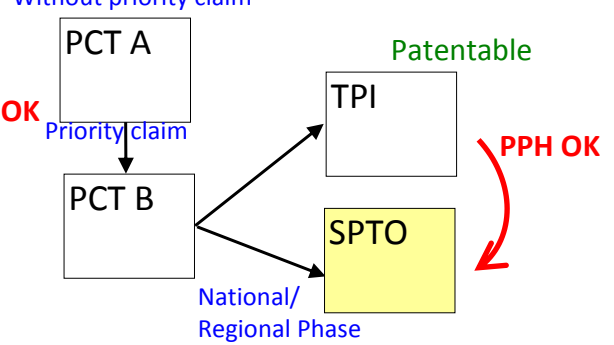

**CASE IV**

I. Paris route

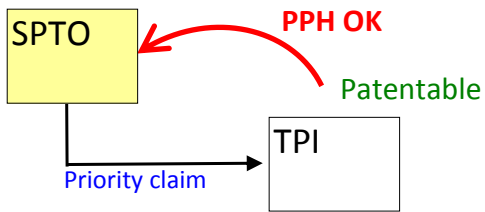

J. PCT route

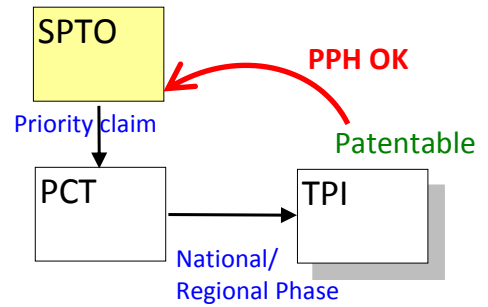

K. Paris route & Complex priority

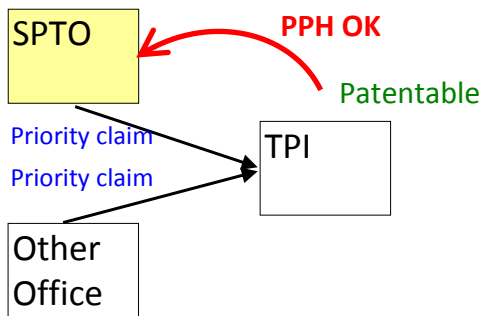

**CASE V**

F. Paris route, the third office

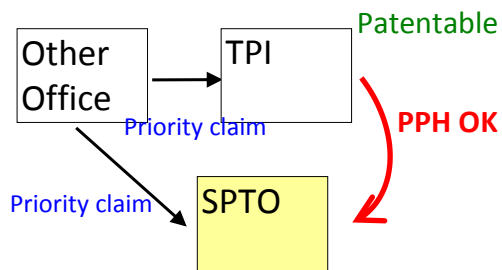

G. PCT route, the third office

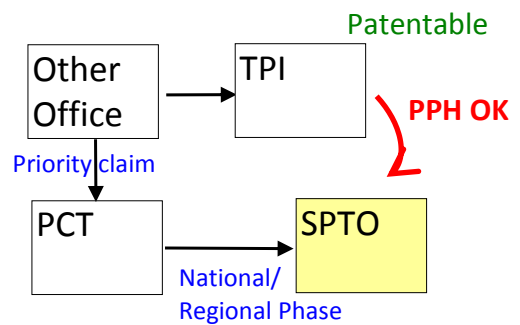

H. PCT route

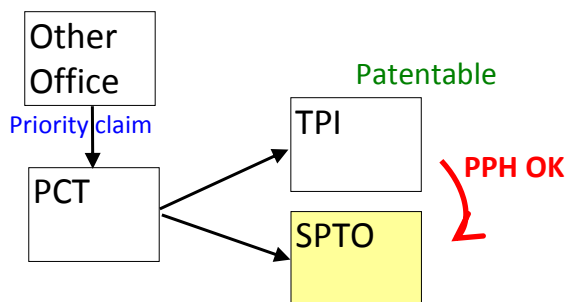

## Annex 2

<b>REQUEST FOR PARTICIPATION IN THE PATENT PROSECUTION HIGHWAY (PPH) PILOT PROGRAM</b>	
<b>A. Bibliographic Data</b>	
Application Number (if known)	
Title	
Date of filing	
Reference	
<b>B. Request</b>	
<b>Applicant requests participation in the Patent Prosecution Highway (PPH) pilot program based on:</b>	
Office of Earlier Examination (OEE)	
OEE Work Products Type	<input type="checkbox"/> National/Regional Office Action(s) <input type="checkbox"/> WO-ISA, WO-IPEA o IPER
OEE Application Number (Incl. PCT Application Number)	
<b>The applicant, if applicable to the circumstances of this case, requests the early publication of the application in accordance with Article 32 (3) of the Spanish Patent Act.</b>	
<b>C. Required Documents</b>	
<b>I. OEE Work Products and, if required, Translations</b>	
1. <input type="checkbox"/> A copy of OEE work products is attached; or <input type="checkbox"/> The office is requested to retrieve documents via the Dossier Access System or PATENTSCOPE	
2. <input type="checkbox"/> A translation of documents in 1 in a language accepted by the Office is attached; or <input type="checkbox"/> The office is requested to retrieve documents via the Dossier Access System or PATENTSCOPE	
<b>II. Patentable/Allowable Claims Determined by OEE and, if required, Translations</b>	
3. <input type="checkbox"/> A copy of all claims determined to be patentable/allowable by OEE is attached; or <input type="checkbox"/> The office is requested to retrieve documents via the Dossier Access System or PATENTSCOPE	
4. <input type="checkbox"/> A translation of documents in 3 in a language accepted by the Office is attached; or <input type="checkbox"/> The office is requested to retrieve documents via the Dossier Access System or PATENTSCOPE	
<b>III. Documents Cited in OEE Work Products (if required)</b>	
5. <input type="checkbox"/> A copy of all documents cited in OEE work products is attached (excluding patent documents); or <input type="checkbox"/> no references cited	
<b>IV. Previously submitted documents</b>	

6.  If any of the above mentioned documents have been submitted before, please specify:

**D. Claims Correspondence**

All the claims in the application sufficiently correspond to the patentable/allowable claims in the OEE application; or

Claims correspondence is explained in the following table

Application Claims	Corresponding OEE claims	Explanation regarding the correspondence

Name(s) of applicant(s) or representative(s)	
Date	
Signature(s) of the applicant / representative	